



Features:

- Specially designed for MIMO applications
- Two RF Channel N inputs
- Quad Polarization for field diversity
- High Efficiency 802.11 ac approved

Performances:

- 4.4-6.1 GHz Gain 24 dB
- Polarization Vertical, Horizontal & Dual Slant ($\pm 45^\circ$) if mounted diagonally
- Maximum power 10 watts CW
- VSWR: < 1.7:1 @ Center freq.
- Aperture E plane and H plane:
 - 8° @ -3 dB
- Front to Back ratio
 - > -35 dB
- Isolation
 - Port to port isolation -30 dB
 - Cross polarization -23 dB

Mechanicals:

- Dimensions 371x371x40 mm
 - 371x371x213 mm with radio rack
 - 371x371x389 mm with mast mount
- Connector 2xN-type, female
- Weight 2.5 Kg
- Mounting support MNT22
- IP-67 Water & Dust Resistant
- Radome Polycarbonate UV protected, White or NATO
- Back Plane Aluminum with chemical passivation
- Operating temperature range -55° to $+65^\circ$
- Vibration conformity IEC60721-3-4
- Win load 200 km/h
- Flammability UL94
- Humidity ETS300 019-1-4, EN 302 085 (Annex A1.1)
- Salt Fog Compliant to IEC 68-2-11

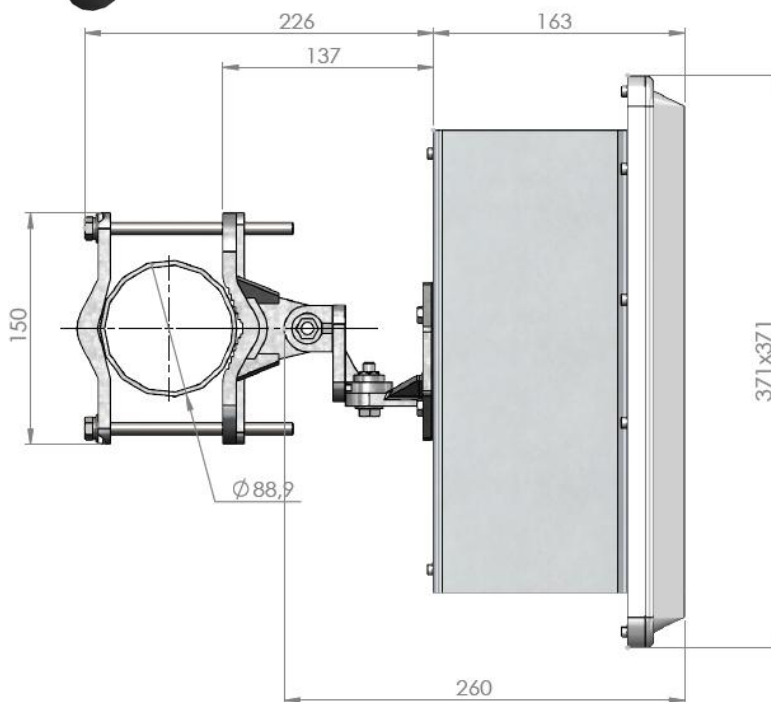
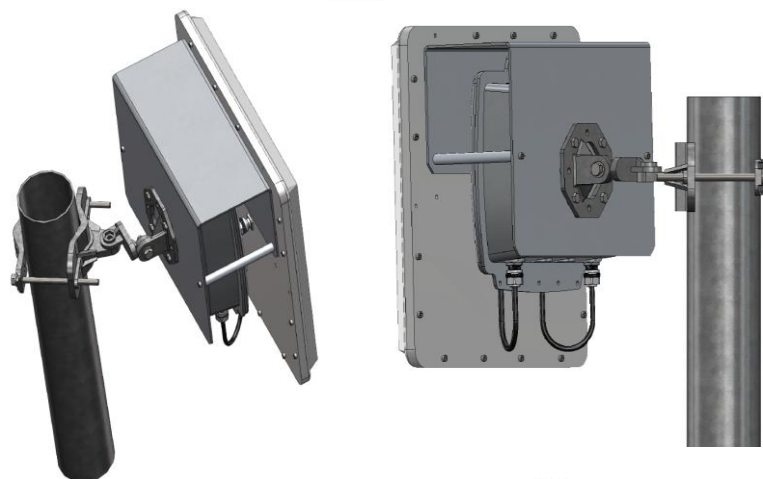

Mounting instructions - Azimuth and Elevation Adjustable Mount MNT-22 REV. 5

1. Align holes of item 2 with 4 studs on back plane of the antenna (not shown).
2. Connect item 2 to the antenna with spring washers (11), plain washers (10) and nuts (12).
3. Tighten the nuts at a torque of 30 Lbs x In.
4. Align item 3 with item 2 so teeth of item 2 face teeth of item 3. Connect with items 6, 7, 8, 13. Leave screw slightly loose.
5. Align item 5 with item 3 so teeth of item 5 face teeth of item 3. Connect with items 6, 7, 8, 13. Leave screw slightly loose.
6. Attach items 4, 5 to the pole as illustrated, and connect them using items 6, 7, 9.
7. Close screws (9) one and another in turn up to tightening torque of each screw is 30...35 Lbs x In.
8. Distance between ends of items 4, 5 on one and another side must be equal. **NO SKEWNESS ALLOWED.**
9. Adjust the desired angle, and fully tighten the loose screws (paragraph 4, 5) at a torque of 30 Lbs x In.
10. Make assemblies as illustrated in Fig. 1, 2.
11. Attach item 5 to the wall. Fasten it with screws 1/4" or M6 using holes 'A'. (Screws not shown).
12. Align item 3 with item 5 so teeth of item 3 face teeth of item 5. Connect as illustrated in Fig. 3.
13. Adjust the desired angle, and fully tighten the loose screws (paragraph 4, 5) at a torque of 30 Lbs x In.

Wall Mounting

NOTE: 1. MOUNT SUITABLE FOR POLES $\phi 1"-4"$.

Parts List		
ITEM	QTY	DESCRIPTION
1	1	POLE 1"-4" (NOT SUPPLIED)
2	1	MNT-22-1
3	1	MNT-22-2
4	1	MNT-22-4
5	1	MNT-22-3
6	4	Helical Spring Lock Washer St. St. #5/16
7	4	Plain Washer St. St. #5/16
8	2	Hex Cap Screw St. St. NC 5/16-18 x 1.25"
9	2	Hex Cap Screw St. St. NC 5/16-18 x 3"
10	4	Plain Washer St. St. #1/4
11	4	Helical Spring Lock Washer St. St. #1/4
12	4	Hex Nut St. St. NC 1/4-20
13	2	Hex Nut St. St. NC 5/16-18

Frequency
Gain, typ.

Radiations Patterns
5400 MHz
25 dBi

Vertical Polarization

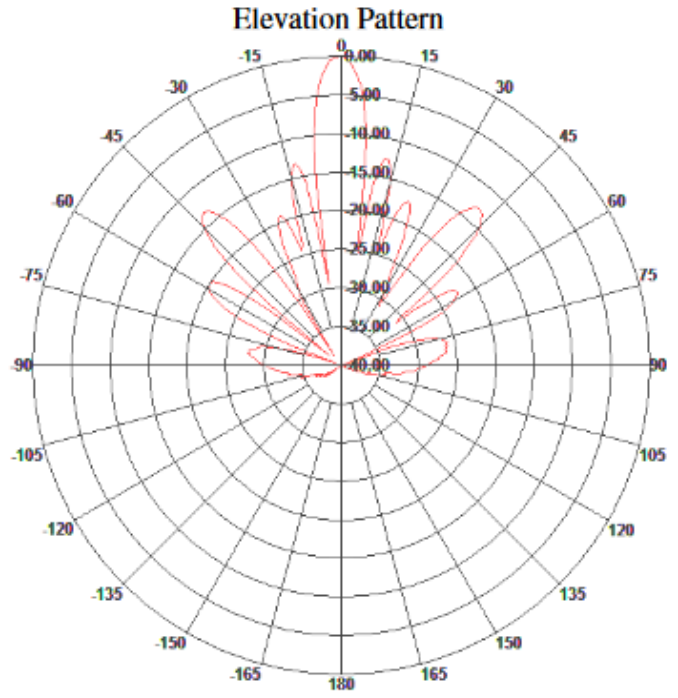
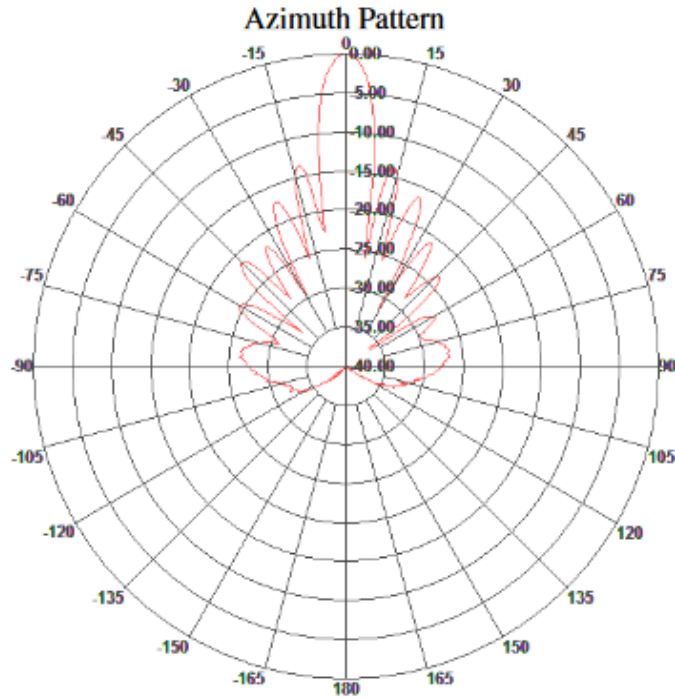

Horizontal Polarization

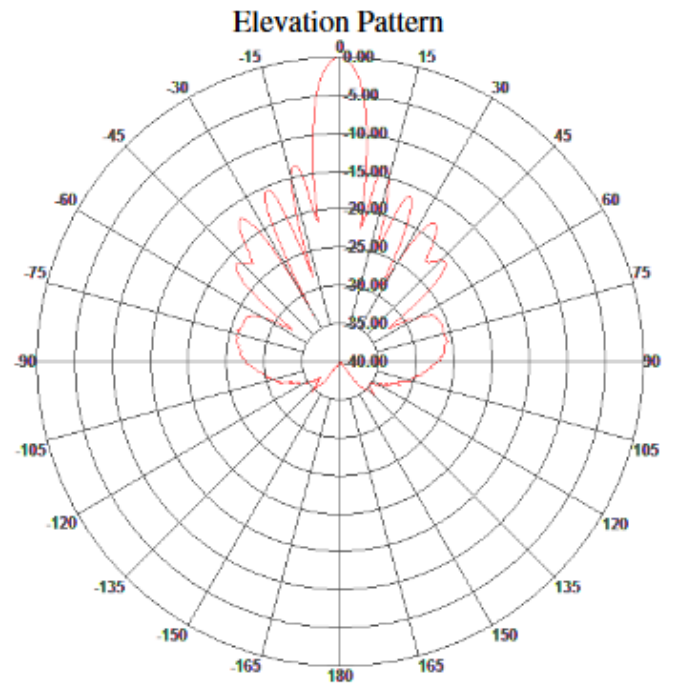
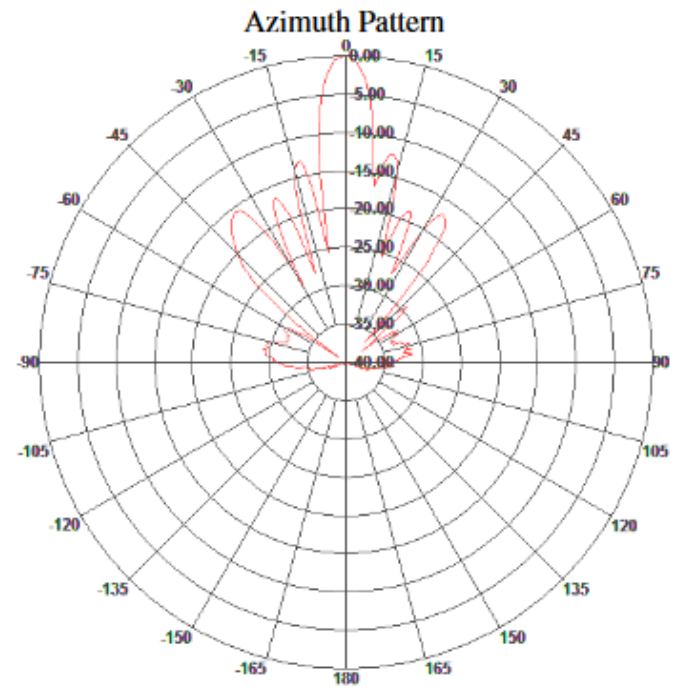

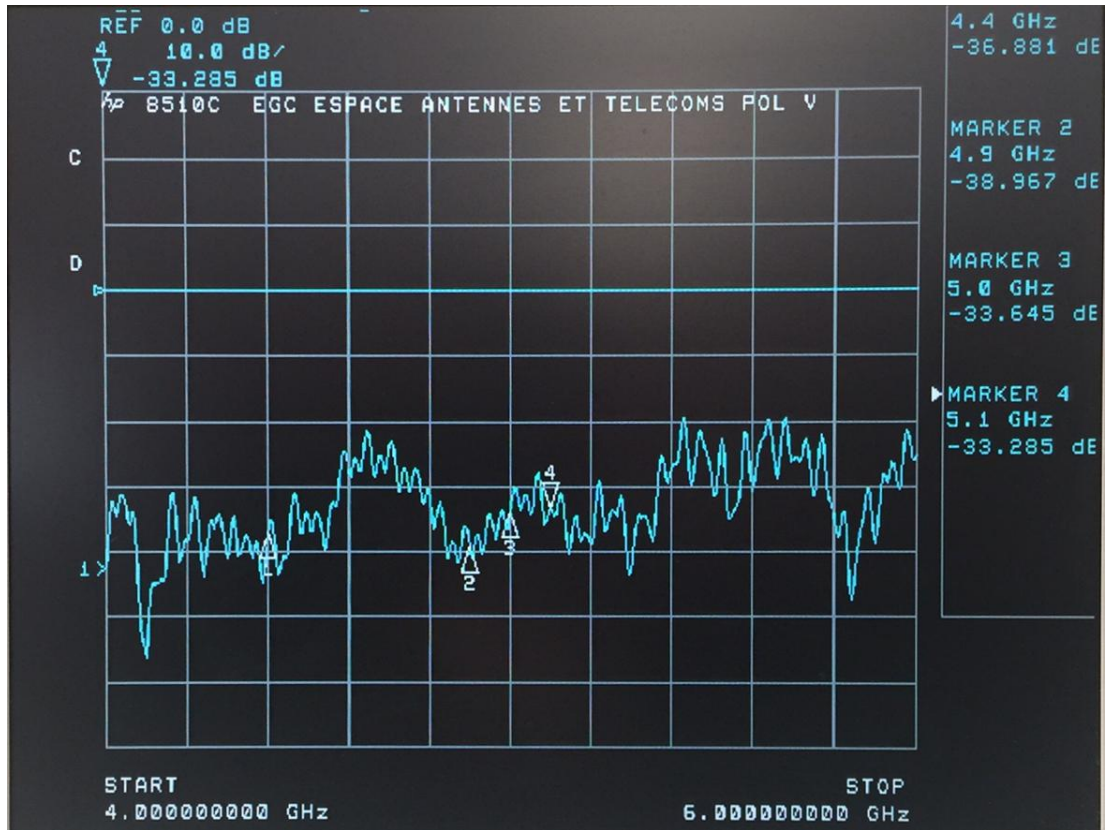

Port H to port V isolation

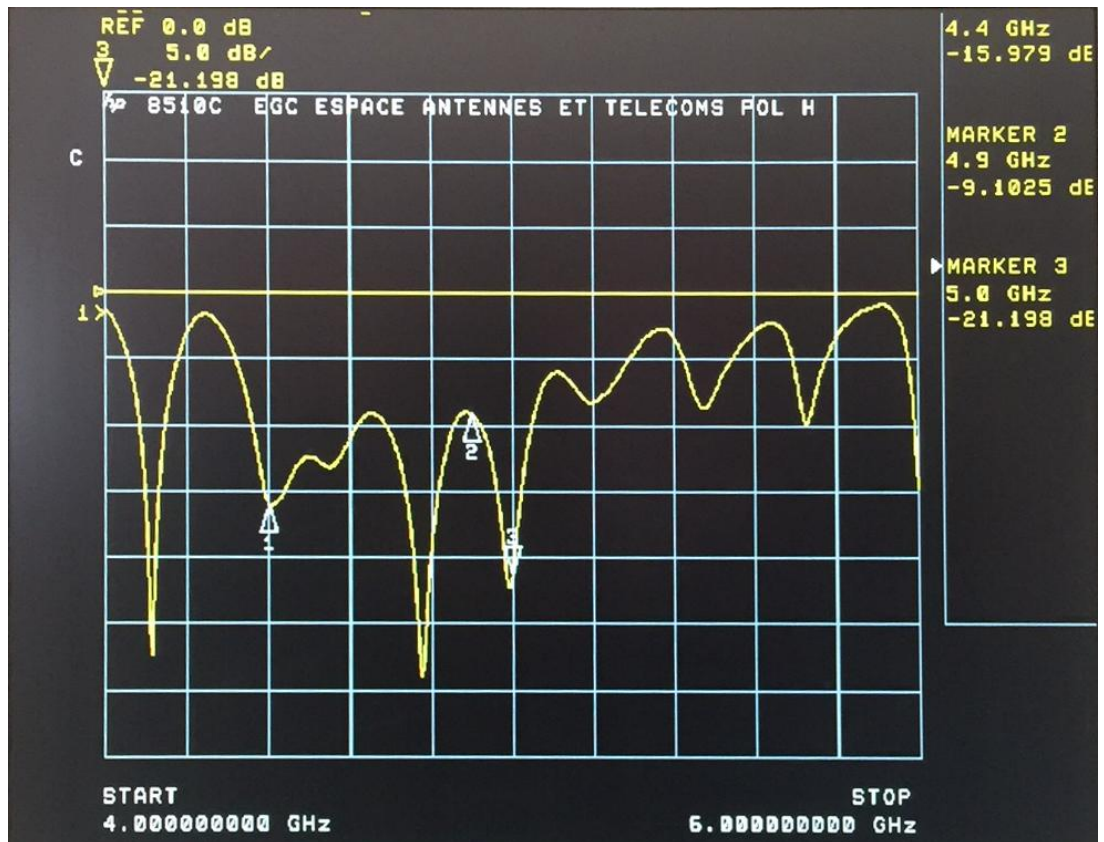

Return loss H port (V port not loaded)

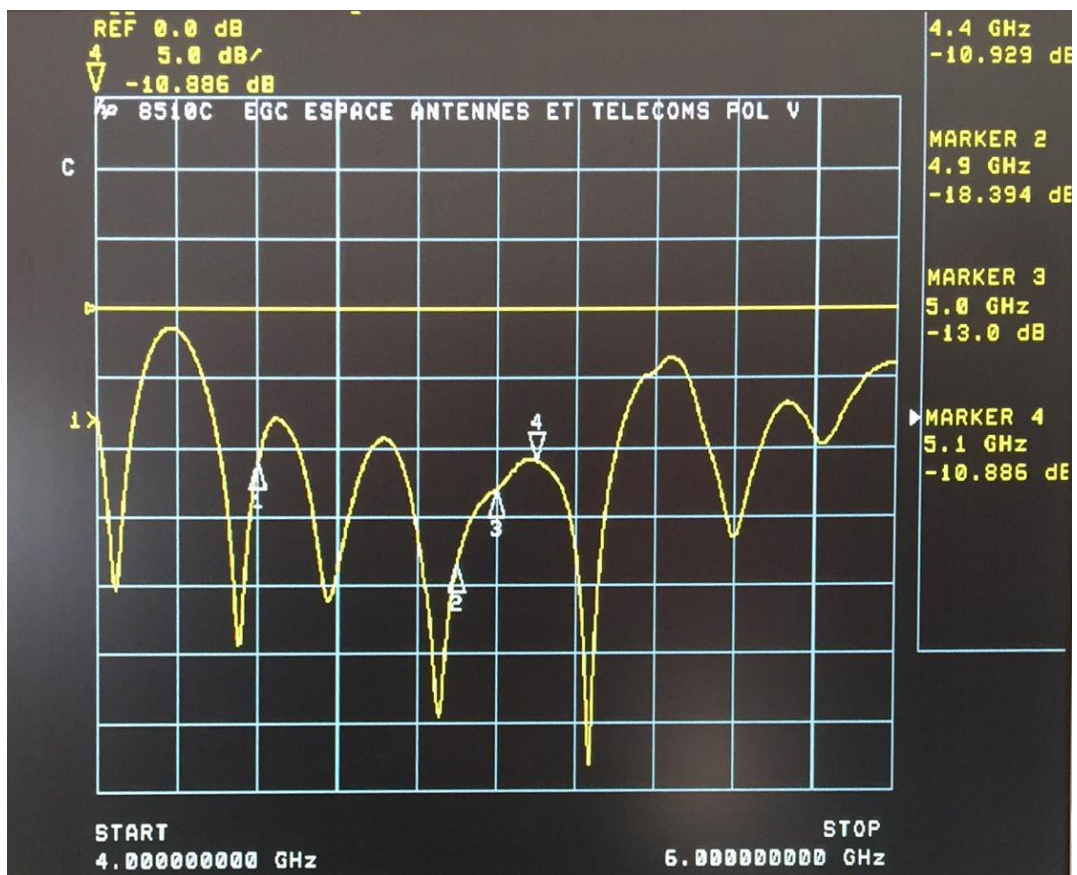

Return loss V port (H port not loaded)



Rear panel with CE and RoHS compliance